



adg lighting  
architectural detail group

# landscape lighting fixtures & follies





 inc.  



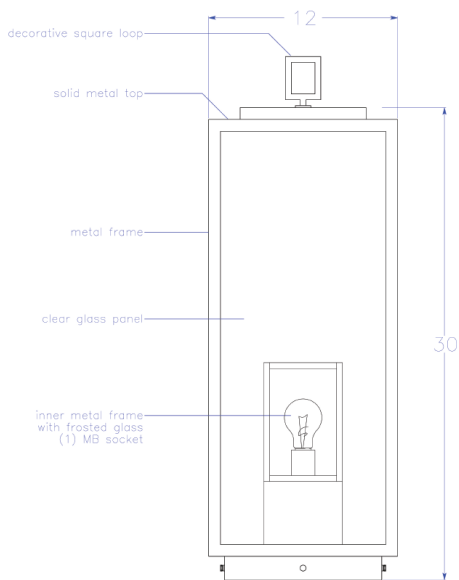

adg lighting  
architectural detail group

Illuminated elegance & curbside to poolside



*Benton Residence*  
**SQUARE PILASTER LANTERN**  
material: brass  
glass: clear / frosted inner frame



**Jardin Tree Light**



**ADG-LED-FL-104B-2W**

Material: Cast Brass  
Finish: Natural Bronze (NBZ)  
Lens: Flat Tempered  
Wattage: 2w (20w Halogen equiv.)  
Color Temperature: 3000K  
Optics: 60° "base optic" (installed) w/ 35° & 15° secondary optic collimators included  
Mounting Option: 8" PVC Stake included  
Dimensions: 4-1/2" h x 1-5/8" w

Seura Hills Newport Beach Dealers Nationwide US & Canada  
1.597.9494 t EcoCA@adg.com  
w/ArchitecturalDetailGroup.com  
w/GoodHortLighting.com  
w/adgLighting.com





Architectural Detail Group, inc.

Welcome to Architectural Detail Group, Inc

We are a collaborative group enhancing the built environment through positive relationships.

The Team here has three generations of manufacturing experience with Decorative Lighting, Furnishings, Furniture, Architectural Ornamentation and Great Quality Customer Service.

There has manufactured for some of the world's finest Homes, Hotels, Resorts & Institution .

The firm has been the predominate design force in the lighting industry with the award winning leadership of Gerald Olesker and the award winning team at AOC Eco Lighting.

Our Collaborative Group's Team has designed and penned lighting for top architects. Designing and manufacturing for forty-two projects for the acclaimed Landry Design Group, we have worked on projects for Robert M Stem, Bellagio Hotel, Lupo's - Wolf Gang Puck. Multi Discipline firms like KAA and our talents and we Top the charts with our CEO being the only lighting designer to have completed twenty-two projects in the renowned Beverly Park. And for the home: Newport Beach Collages to Martha's Vineyard.

Who are we; We are the Greatest Lighting Team and Manufacturers you will meet

ADG Eco Lighting Products. Architectural Detail Group, Inc ADO Lighting & AOO Ironworks Gemtd Olesker Signature Series Post Licensee of; Hearst Castle Collection of Decorative Lighting & Iron NPO Lanterns

New Providence 1st floor

Private label for the most exclusive Melrose to NY Showroom.

Why this Design and no catalog.

Enjoy this selection of 300+ of our Hand Made Order Designs.

Customize and change any fixture to meet you or your clients' exclusive tastes. Redesign our pieces: to meet your budgets.

Order anything the way you see it. Enjoy a legacy of artisanship and well made pieces.

Keep coming back to hotel and Contract. Residential and Resort or Fashion Centers all have collaborated with our team. You will too when you meet w.

Thousand of Projects completed all over the Globe - Fixtures Made In America

Cage: 59TAI Duns: 198358579 NA[CS: 335129, 331724, 541420 FSC: 5975, 6210, 6240

ARCHITECTURAL DETAIL GROUP

10-31-2024 (C)

LANTERN

SIDE

AT WALL

34

# BEACH



6W LED E.T. PATH LIGHT  
ADG-LED-PS-113B-6W

Material: Cast Brass  
Finish: Natural Bronze (NBZ)  
Lead Wire: 3ft 18 awg SPT-1  
Lens: Clear Tempered installed (Frost optional)  
Wattage: 6w (35-42w Halogen equiv.)  
Color Temp: 3000K  
Optics: Optics: N/A  
Mounting: 8" PVC Stake included

## ADG-FL-113B-T3

- Material: Material: Cast Brass
- Finish: Natural Bronze (NBZ)
- Lens: Frost, Clear or Linear
- Lead Wire: 3ft 16 awg SPT-1

Ag...  
818.597.9494  
www.ArchitecturalDetailGroup.com  
www.GreenHardware.com



For more info about sales of these vintage items or reproductions  
Contact ADG Lighting [info@adglighting.com](mailto:info@adglighting.com) 818-597-9494

## •Fixture Dimensions: 4-1/2" w x 3" h

- Max Lamp:  
35w T3 (20w T3 included)
- Mounting Option:  
8" PVC Stake included

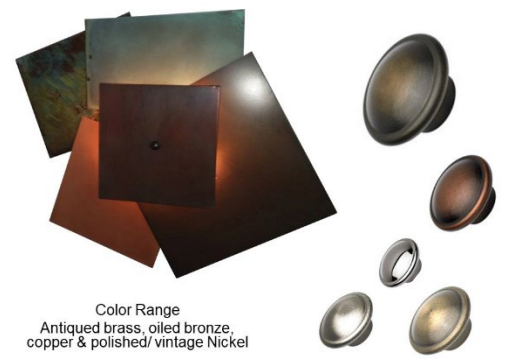

Color Range  
Antiqued brass, oiled bronze,  
copper & polished/vintage Nickel



**ADG-LED-FL-104B-2W**

**Material:** Cast Brass

**Finish:** Natural Bronze (NBZ)

**Lens:** Flat Tempered

**Wattage:** 2w (20w Halogen equiv.)

**Color Temperature:** 3000K

**Optics:** 60° "base optic" (installed) w/ 35° & 15° secondary optic collimators included

**Mounting Option:** 8" PVC Stake included

**Dimensions:** 4-1/2"h x 1-5/8"w

Agoura Hills Newport Beach Dealers Nationwide US & Canada  
818. 597. 9494 t EcoCA@adgmail.com  
[www.ArchitecturalDetailGroup.com](http://www.ArchitecturalDetailGroup.com)  
[www.GreenHotelLighting.com](http://www.GreenHotelLighting.com)  
[www.adgLighting.com](http://www.adgLighting.com)



Bulb & photometry based on lamp style

**LED BIG ROLL**

**ADG-LED-FL-105B-6W**

- Material:** Cast Brass
- Finish:** Natural Bronze (NBZ)
- Lens:** Flat Tempered
- Wattage:** 6w (35-42w Halogen equiv.)
- Color Temperature:** 3000K
- Optics:** 60° "base optic" (installed)  
w/ 35° & 15° secondary optic  
collimators included
- Mounting Option:**  
8" PVC Stake included
- Dimensions:** 6-1/2"h x 2-3/8"w





**120V PAR 20**

**ADG-FL-120B-PAR20**

- **Material:** Brass
- **Finish:** Finish: Natural Bronze (NBZ)
- **Lens:** Tempered
- **Lead Wire:** 3ft 18 awg SPT-2
- **Dimensions:** 8-1/2" h x 3-1/2" w
- **Max Lamp:** 50w 120v par20
- **Mounting Option:** 1/2" NPT

Bulb & photometry based on lamp style



Landscape lighting made to order



**120V PAR 30**

**ADG-FL-130B-PAR30**

- **Material:** Brass
- **Finish:** Natural Bronze (NBZ)
- **Lens:** Tempered
- **Lead Wire:** 3ft 18 awg SPT-2
- **Dimensions:** 9-1/2" h x 4-3/4" w
- **Mounting Option:** 1/2" NPT threading

Bulb & photometry based on lamp style

Landscape lighting made to order



**120V PAR 38**

**ADG-FL-138B-PAR38**

- **Material:** Brass
- **Finish:** Natural Bronze (NBZ)
- **Lens:** Clear Tempered
- **Lead Wire:** 3ft 18 awg SPT-2
- **Dimensions:** 11-1/2" h x 6-1/4" w
- **Max Lamp:** 100w 120v par38
- **Mounting Option:** 1/2" NPT threading

Bulb & photometry based on lamp style

# Landscape lighting made to order

## 120V PAR 38

### ADG-FL-138B-PAR38

- **Material:** Brass
- **Finish:** Natural Bronze (NBZ)
- **Lens:** Clear Tempered
- **Lead Wire:** 3ft 18 awg SPT-2
- **Dimensions:** 11-1/2”h x 6-1/4” w
- **Max Lamp:** 100w 120v par38
- **Mounting Option:** 1/2” NPT  
threading



Bulb & photometry based on lamp style

**MOON DAY GRANDE**  
**ADG-FL-175B-MR16**

- Material:** Cast Brass
- Finish:** Finish: Natural Bronze (NBZ)
- Lens:** Clear Tempered
- Lead Wire:** 3ft 16 awg SPT-1
- Dimensions:** 9" h x 4" w
- Max Lamp:** 75w MR16
- Mounting Option:** 9" PVC Stake included



Bulb & photometry based on lamp style

**CAST BRASS CUBAN**  
**ADG-FL-917B-PAR36-25**

- **Material:** Cast Brass
- **Finish:** Natural Bronze (NBZ)
- **Lens:** Tempered
- **Lead Wire:** 3ft 16 awg SPT-1
- **Dimensions:** 4" h x 5" w
- **Max Lamp:** 50w Par36
- **Mounting Option:** 9" PVC Stake included



Bulb & photometry based on lamp style



**EYEBROW**

**ADg-SD-406B-T3**

- **Material:** Cast Brass
- **Finish:** Natural Bronze (NBZ)
- **Lens:** Frost Tempered (NBZ)
- **Lead Wire:** 3ft 18 awg SPT-1 (NBZ)
- **Dimensions:**  
3-1/2" diameter x 2"h (NBZ)
- **Max Lamp:**  
20w T3 included(NBZ)

Bulb & photometry based on lamp style



**GRILL**

**ADG-SD-407B-T3**

- **Material:** Cast Brass
- **Finish:** Natural Bronze (NBZ)
- **Lens:** Frost Tempered
- **Lead Wire:** 3ft 18 awg SPT-1
- **Dimensions:**  
3-1/2" diameter x 1-1/2"h
- **Max Lamp:**  
20w T3 included

Bulb & photometry based on lamp style

Landscape lighting made to order



**MULTI COVER**  
ADG-IG-55B\



ADG-IG-50B



ADG-IG-56B



ADG-IG-56B



**UNIVERSAL IN-GROUND MR16**  
ADG-IG-00P-MR16

•Material: Composite with  
ABS outer sleeve

•Finish: BK

•Lead Wire: 3ft 18awg SJT cord

•Dimensions: 5" h x 4" w

•Max Lamp: 20w MR16

Bulb & photometry based on lamp style



# Landscape lighting made to order

## PAR WELL

ADG-IG-300P-PAR36

- **Material:** Material: ABS/SS
- **Finish:** Black
- **Lead Wire:** 3ft 18 awg SPT-1
- **Dimensions:** Dimensions: 8" h x 5-1/2" w
- **Max Lamp:** 50w Par 36
- **Aiming:** Aiming: Stainless steel adjustable gimbal rotates



WELL TRIM COVER  
ADG-IG-303P-BG



WELL TRIM COVER  
ADG-IG-302P



WELL TRIM COVER  
ADG-IG-344B-DG

Bulb & photometry based on lamp style

# Landscape lighting made to order

## **LUNA CLASSICO** **ADG-AP-201B-T3**

- **Material:** Cast Brass
- **Finish:** Natural Bronze (NBZ)
- **Lens:** Hi Temperature Poly Carbonate Tube
- **Lead Wire:** 3ft 16 awg SPT-1
- **Dimensions:** 22'H x 6-1/2"w
- **Max Lamp:** 20w T3 Included
- **Mounting Option/Application:** 9" PVC Stake included
- **Light Spread:** 8ft



Bulb & photometry based on lamp style

adg lighting  
architectural detail group

Landscape lighting made to order

**LUNA JARDIN SHADE**  
**ADG-AP-08B**

- Shade Diameter: 6.75"
- Light Spread: 7-9ft



Bulb & photometry based on lamp style

adg lighting  
architectural detail group

Landscape lighting made to order

**LUNA FLORES SHADE**  
**ADG-AP-12B**

- Shade Diameter: 8"
- Light Spread: 8-10ft



Bulb & photometry based on lamp style

# Landscape lighting made to order

## LED 10" UNDER CAP

### ADG-LED-UC-10-6W

- **Material:** Cast Brass
- **Finish:** Natural Bronze (NBZ)
- **Lead Wire:** 10ft 18 awg SPT-1
- **Lens:** Frost Polycarbonate
- **Wattage:** 6w (35-42w Halogen equiv.)
- **Color Temperature:** 3000K
- **Optics:** N/A
- **Mounting Option:** 4" rectangular in wall plate
- **Dimensions:** 10" x 1" x 1"



Bulb & photometry based on lamp style

Custom make linear light

adg lighting

architectural detail group

Landscape lighting made to order



**LED TRANSFORMER**

100w 12v Outdoor rated black finish transformer  
w/ integrated digital timer and photocell.

**ADG-TR-LED-100-PL104T-BK**

**Volts: 12**

**Watts: 100**

**Weight: 6lbs**

**Dimensions: 7"l x 4"w x 4"**

Specified per tree

Agoura Hills Newport Beach Dealers Nationwide US & Canada  
818. 597. 9494 t EcoCA@adgmail.com  
[www.ArchitecturalDetailGroup.com](http://www.ArchitecturalDetailGroup.com)  
[www.GreenHotelLighting.com](http://www.GreenHotelLighting.com)  
[www.adgLighting.com](http://www.adgLighting.com)



Transformers up to 1500 watts

Landscape lighting made to order



Jardin Tree Light



8960-st-g tree



5290 Flood Copper



8951-br-g tree light  
LED or low voltage  
lighting by ADG Eco ADG

Bulb & photometry based on lamp style

# Landscape lighting made to order

4



**CONFIGURE**  
Wall bracket



**CONFIGURE**  
Single stake

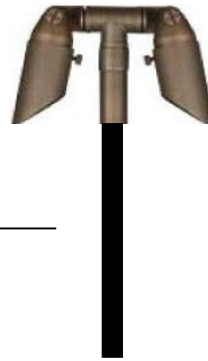
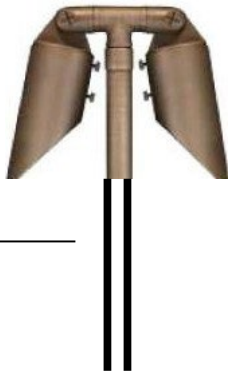

**CONFIGURE**  
Double stake

**CONFIGURE**  
Specify height



# Landscape lighting made to order

## CONFIGURE Base path light

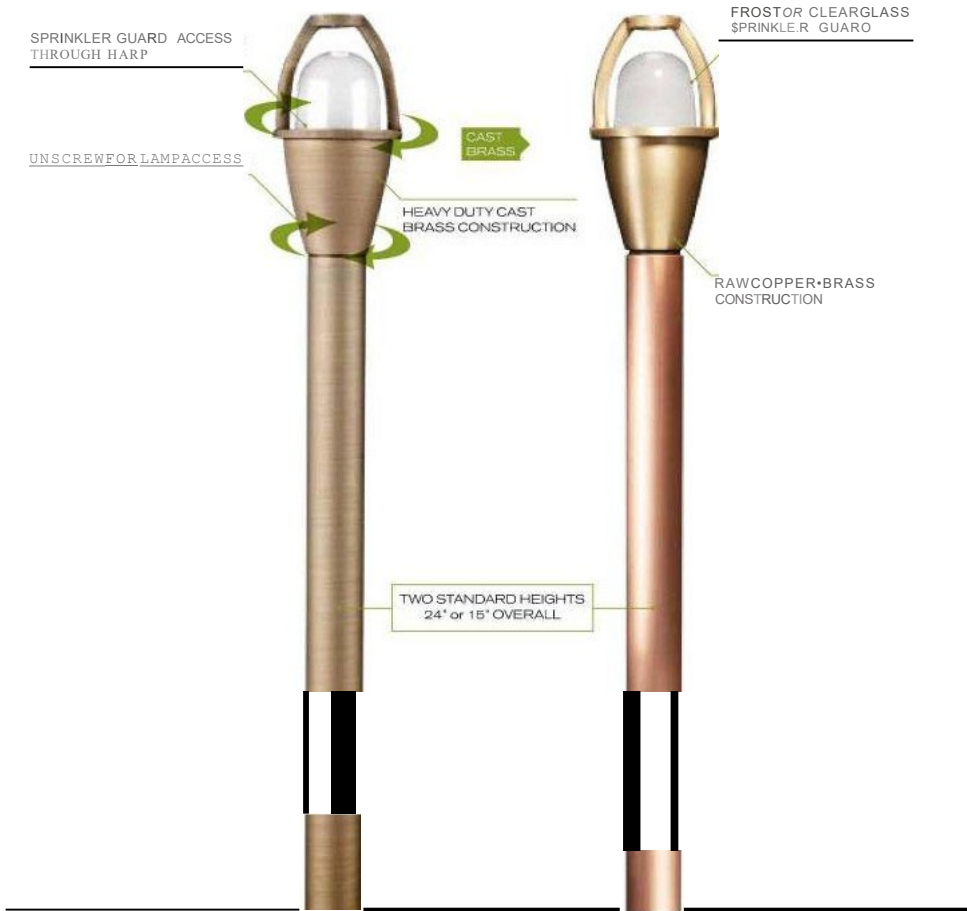

### LACE



### SPREAD



### JARDIN



### SPUN



### DOUBLE



LUNA PERFECTO SHADE

adg lighting

architectural detail group

# Landscape lighting made to order



8950-br-g



8951-br-g



8960-st-g



8990-ir-g

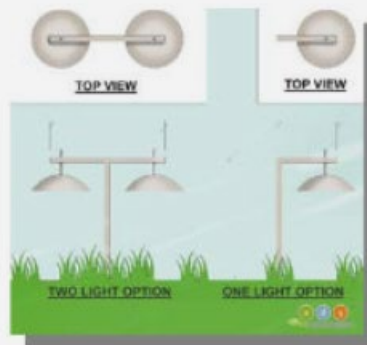

8954-br-g 8955-br-g



8956-br-g

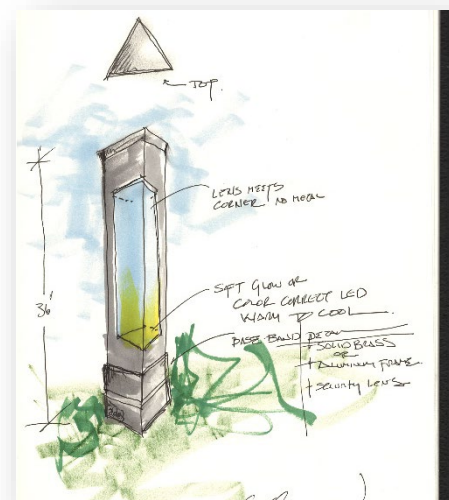
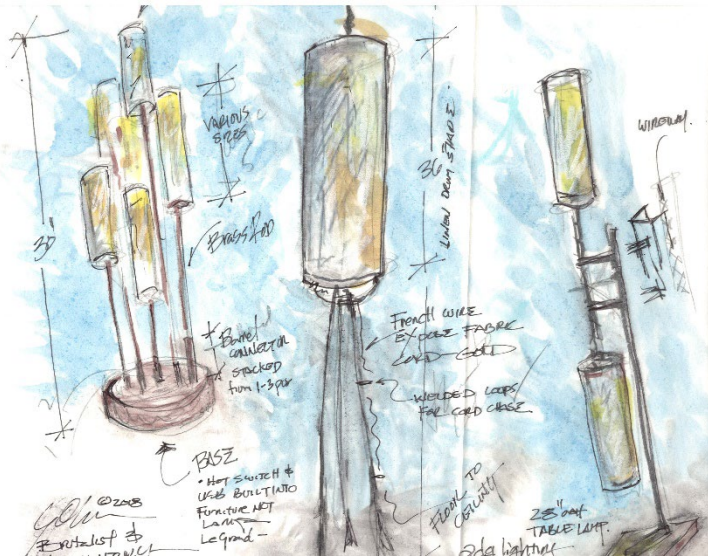

Custom made design

# Landscape lighting made to order



**PETITE PATH**  
**ADG-AP-200B-T3**

Material: Cast Brass  
Finish: Natural Bronze (NBZ)  
Lens: Hi Temperature Poly Carbonate Tube  
Lead Wire: 3' 16 AWG SPT-1  
Dimensions: 2 1/4" h x 4 1/4" w  
Max Lamp: 2W T3 Included  
Mounting Option/Application: 9" PVC Stake, nctud8d  
Light Spread: 6ft



**LUNA CLASSICO**  
**ADG-AP-201B-T:3**

Material: Cast Brass  
Finish: Natural Bronze (NBZ)  
Lens: Hi Temperature Poly Carbonate Tube  
Lead Wire: 3ft 16 AWG SPT-1  
Dimensions: 2 1/2" h x 6 1/4" w  
Max Lamp: 2W T3 Included  
Mounting Option/Application: 9" PVC Stake, nctud8d  
Light Spread: 8ft



**LUNA 11:SCORT**  
**ADG-AP-214B-T3**

Material: Cast Brass  
Finish: Natural Bronze (NBZ)  
Lens: Convex w/ frost SPlinkler Guard  
Lead Wire: 31116 awg SPT-1  
Dimensions: 2 1/4" h x 5 1/2" w  
Max Lamp: 2W T3 Included  
Mounting Option/Application: 9" PVC Stake, nctud8d  
Light Spread: 8-15ft



**E.T. PATH LIGHT**  
**ADG-PS-113B-T3**

Material: cast Brass  
Finish: Natural Bronze (NBZ)  
Lens: Frost, Clear or Linex  
Lead Wire: 31116 awg SPT-1  
Dimensions: 1 1/2" h x 3" w (22" Post)  
Max Lamp: 35w T3 (20W T3 Included)  
Mounting Option/Application: 9" PVC Stake, nctud8d  
Light Spread: 6-8ft



Custom stem heights available.  
Call your authorized Advantage Light Source distributor or representative for details.

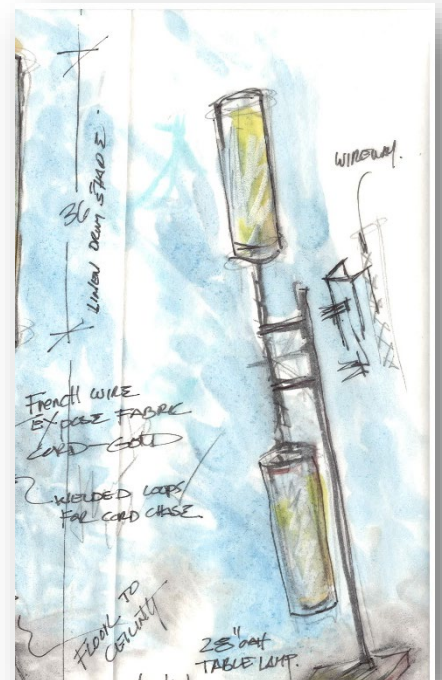

# Landscape lighting made to order

**TR-300-12 15**  
Volts: 12-15 / Wats: 300 / Weight 15lbs  
Dimensions: 14"x5.20"w x 4.75"d

**TR-600-12 15**  
Volts: 12-15 / Wats: 600 / Weight 24lbs  
Dimensions: 14"x5.20"w x 4.75"d

**TR-900-12 15**  
Volts: 12-15 / Wats: 900 / Weight 31lbs  
Dimensions: 19"x5.20"w x 5.5"d

**TR-1200-12 15**  
Volts: 12-15 / Wats: 1200 / Weight 41lbs  
Dimensions: 19"x5.20"w x 5.5"d

**TR-600-12 22**  
Volts: 12-22 / Wats: 600 / Weight 130lbs  
Dimensions: 14"x5.20"w x 4.75"d

**TR-900-12 22**  
Volts: 12-22 / Wats: 900 / Weight 47lbs  
Dimensions: 19"x5.20"w x 5.5"d

**TR-1200-12 22**  
Volts: 12-22 / Wats: 1200 / Weight 49lbs  
Dimensions: 19"x5.20"w x 5.5"d



**LED TRANSFORMERS**

**TR-LED-100-PL 104T-BK**  
Volts: 12 / Wats: 100 / Weight 6lbs  
Dimensions: 4"x4"x4"

**TR-LED-200-PL 106T-8K**  
Volts: 12 / Wats: 200 / Weight 12lbs  
Dimensions: 9"h x 5"w x 5"d

**TRANSFORMER ACCESSORIES**

**STANDARD TIMER**  
ITEM# TR-T-101

**PHOTOCELL**  
ITEM# TR-TP-102

**DIGITAL ASTRONOMICAL TIMER**  
ITEM# TR-T-105

\*All Stainless Steel, Photocell+ Timer Ready

0

## ACCESSORIES



Let us know  
what  
additional  
components  
you need.  
We have it.

adg lighting  
architectural detail group

Landscape lighting made to order

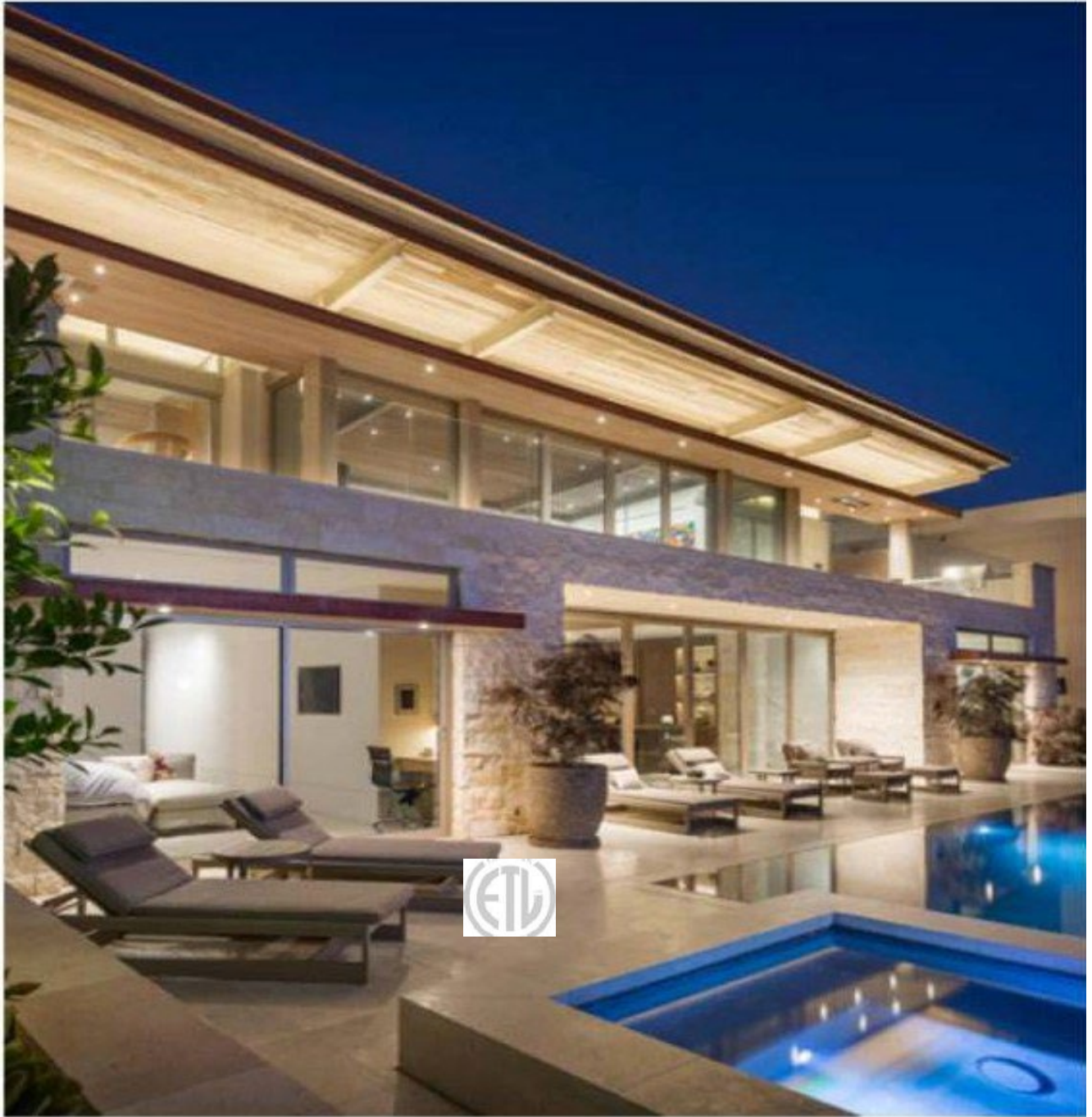

adg lighting

architectural detail group

Landscape lighting made to order





**adg** inc.  
eco LIGHTING PRODUCTS

**Lantern**



#202-cb4-br-p-ba  
Calabasas Brass Lantern with Pilaster Base  
Shown with 'Seedy Glass & 'Rustic Brown Finish  
Shown 10" wide  
Custom Sizes & Materials Available

Agoura Hills Newport Beach Dealers Nationwide US & Canada  
818. 597. 9494 t EcoCA@adgmail.com  
www.ArchitecturalDetailGroup.com  
www.GreenHotelLighting.com  
www.adgLighting.com



ASK ABOUT ENERGY STAR

fixtures made to architectural standards

adg lighting

architectural detail group

Landscape lighting made to order



#308 b- Gas Lantern

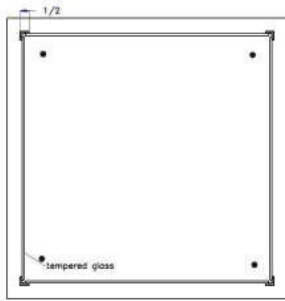
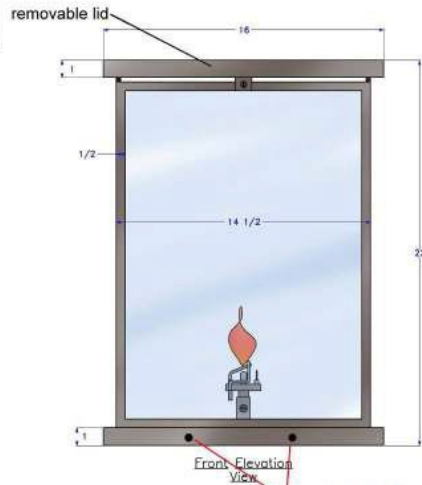

Cut View

Front Elevation View

air holes

308b-ga-st-p-ba  
modern\_lantern\_gas\_light\_

Agoura Hills Newport Beach Dealers Nationwide US & Canada  
818.597.9494 t EcoCA@adgmail.com  
www.ArchitecturalDetailGroup.com  
www.GreenHotelLighting.com  
www.adgLighting.com



Gas is roomantic

adg lighting

architectural detail group

Landscape lighting made to order



[www.adgLighting.com](http://www.adgLighting.com)

710.5-cb1-ir-pil-ba

818-597-9494

Place decorative in the landscape



adg lighting

architectural detail group

Landscape lighting made to order

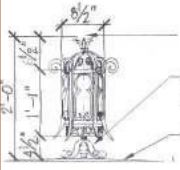

FLUER DE LIS)

SCROLLED TRI-POD BASE  
CONCEALS MOUNT AND  
ELECTRICAL CONNECTION

PRE-CAST PILLAR CAP





**Lantern**



**#610-mb1-ir-p-ba**

Iron Forged Pilaster Lantern ~ Leon  
shown with Seeded Glass ~ Bronze True fleck Oxidized Finish  
6 sided ~ order with or without scrolled base  
Custom Sizes & Alternate Materials Available

Agoura Hills Newport Beach Dealers Nationwide US & Canada  
818. 597. 9494 t EcoCA@adgmail.com  
www.ArchitecturalDetailGroup.com  
www.GreenHotelLighting.com  
www.adgLighting.com



ASK ABOUT ENERGY STAR

Balance landscape lights

adg lighting  
architectural detail group

Landscape lighting made to order



**Oceana Lantern**



660-mb2-ir-s-ba oceanic\_large\_wall\_lanten\_

Transitional\_lighting\_ contemporary\_ 3 lights on Square fitters

Approximately 48" tall – custom sizes available

Agoura Hills Newport Beach Dealers Nationwide US & Canada  
818. 597. 9494 t EcoCA@adgmail.com  
www.ArchitecturalDetailGroup.com  
www.GreenHotelLighting.com  
www.adgLighting.com



fixtures made to architectural standards

adg lighting

architectural detail group

Landscape lighting made to order



**Modern Pilaster Lantern**



# 790 - mb1 - jc - p - sh

Modern Pilaster\_Lantern ADG\_Lighting

LED meets title 24 or other available light sources

Approximately 24" Wide

12" High + base mounts to pilaster with internal make up plate.

Custom sizes available

Agoura Hills Newport Beach Dealers Nationwide US & Canada  
818. 597. 9494 t EcoCA@adgmail.com  
www.ArchitecturalDetailGroup.com  
www.GreenHotelLighting.com  
www.adgLighting.com



Modern pilasters

adg lighting

architectural detail group

Landscape lighting made to order



**Modern Pilaster Lantern**

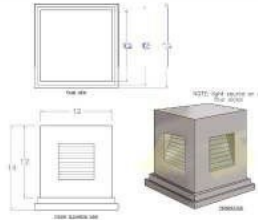

# 792-ind-br-p-sh Induction\_Square Pilaster\_light  
LED meets title 24 or other available light sources

Approximately 14" cube  
mounts to pilaster with internal make up plate.  
Custom sizes available

Agoura Hills Newport Beach Dealers Nationwide US & Canada  
818. 597. 9494 t EcoCA@adgmailto.com  
www.ArchitecturalDetailGroup.com  
www.GreenHotelLighting.com  
www.adgLighting.com



fixtures made to architectural standards

adg lighting

architectural detail group

Landscape lighting made to order



Lantern

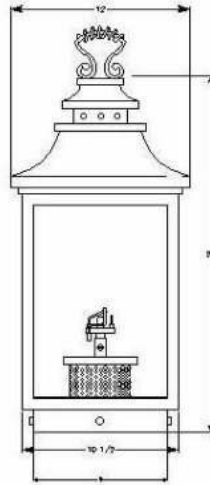

# 915-ga-sr-w-sh

Steel Lantern ~ Shown in textured bronze & clear glass  
14" square frame + yoke (shown on dwg. only)  
Check all local codes for Gas fired appliances  
Thermal coupler shut off

~~~~~  
Customizable sizes available ~ Electric available  
Alternate Materials i.e. brass/ copper available ~ (glass options avl)  
Wall mount & pendants available

Agoura Hills Newport Beach Dealers Nationwide US & Canada  
818.597.9494 t EcoCA@adgmail.com  
www.ArchitecturalDetailGroup.com  
www.GreenHotelLighting.com  
www.adgLighting.com

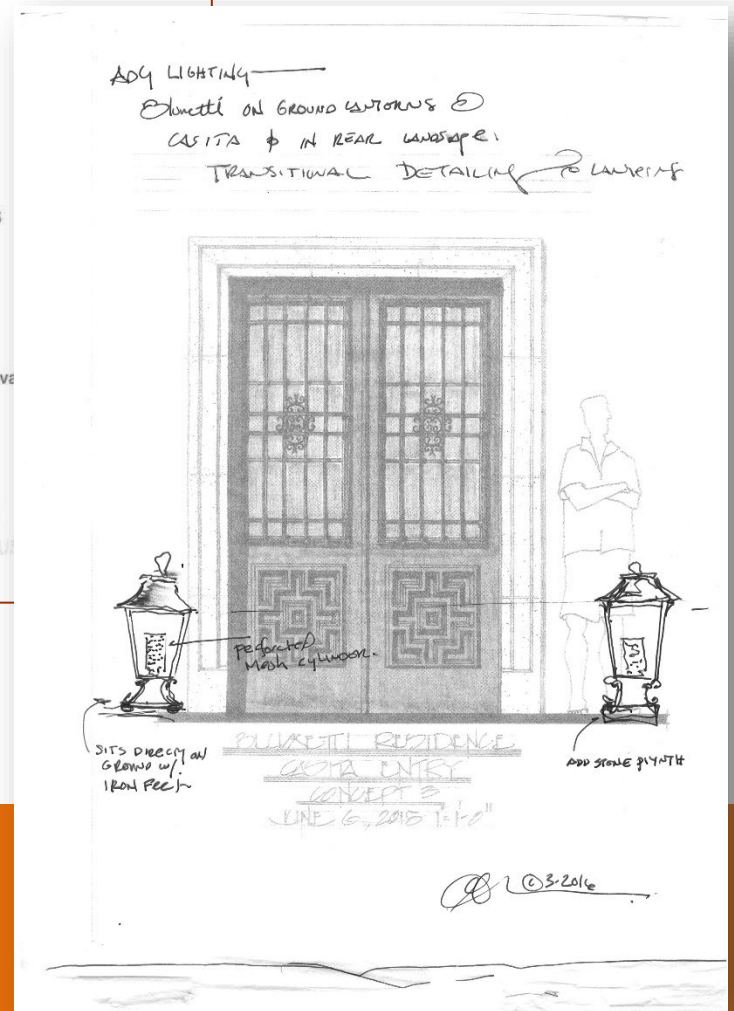

Create & fabricate

adg lighting

architectural detail group

Landscape lighting made to order



**Lantern**

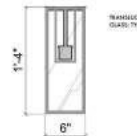

968-mbl-br-Pilaster or ground mount

Transitional\_lantern\_contemporary\_brass\_lantern\_oil\_bronze\_finish\_

Custom Sizes available

Agoura Hills Newport Beach Dealers Nationwide US & Canada  
818. 597. 9494 t EcoCA@adgmail.com  
www.ArchitecturalDetailGroup.com  
www.GreenHotelLighting.com  
www.adgLighting.com



Ask about Dark-sky compliance

# Landscape lighting made to order



810-mb2-brp-sh  
Cast Glass



862-mb1-st-pi-ba  
copper plated  
landscape lantern

All of our Lanterns are made to order  
Call for Specs & Details



959 Kemble Pilaster



968.5 large Pilaster

  
www.adgLighting.com  
818-597-9494

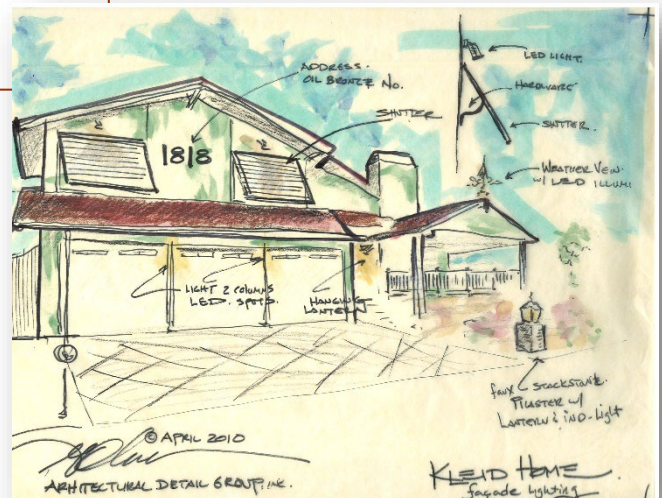

# Landscape lighting made to order



80590-ind-ir-w -ba  
Induction Lantern



800-mb1-br-p-sh  
Craftsman Lantern



690-cb4-br-p-shwo  
Lantern on wooden post



710-cb4-ir-p-ba  
Mount Rustico  
Pilaster Lantern



655-ga-br-p-sh  
Brass gas pilaster



720-mb1-br-p-sh  
Jessy Pilaster



[www.adgLighting.com](http://www.adgLighting.com)

818-597-9494





# Landscape lighting made to order

Architectural Detail Group, inc.



610-mbl-ir-p-ba



630-cb3-albr-p-shca

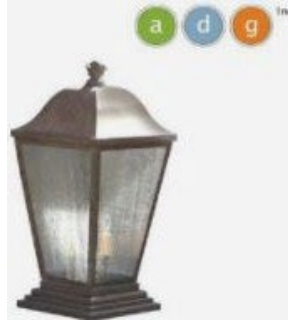

202-cb4-<br-sh



640-cb1-br-p-sh



621-al\*p-ca & 625-cb4-br-p-sh



6 m b 1 - br-p-sh



660-mb4-ir-w-ba



670cb1-p-sh



680-cbS-ir-p-ha



69<kb4-br-p-shwo



700-mbl-br-p-sh

III  
C  
g  
i  
C  
t:  
i  
al'  
:  
:  
:  
:  
:  
Q





Architectural Detail Group, inc.

50,000 hours  
LED



100,000 hours  
Induction

ASK ABOUT  
ENERGY STAR

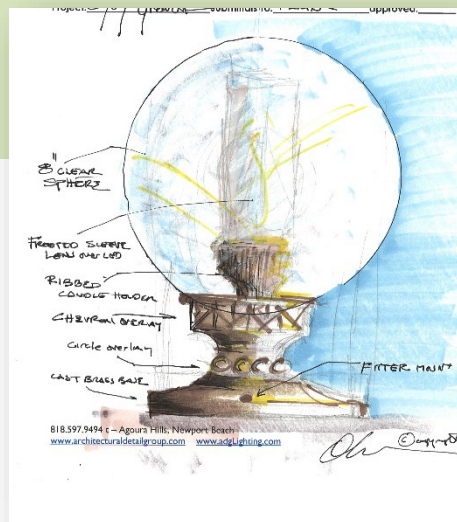

8950-br-g



8951-br-g



89C,Qs1-g

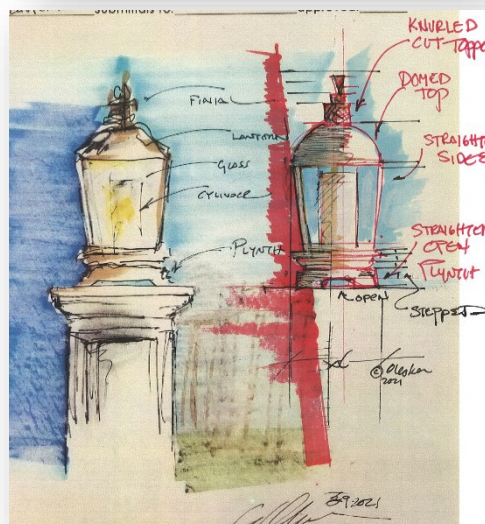

8990-ir-g

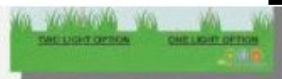

8954-br-g 8955-br-g



8956-br-g



89&0-ir-g



8972-cb4-br-<h\*\*

Ask about Dark-sky compliance

# Ask about landscape products

Architectural Detail Group.inc.



8080-br metal corbel

.J08

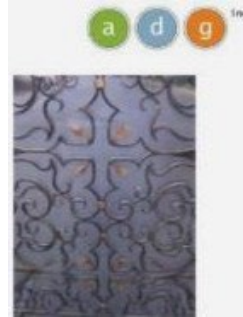

8900-ir screen



8970-ti ornament



8910-irco iron and copper gate



8920 br c.t ornament

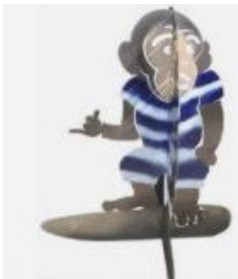

Surf Monkey board shorts



8910-ir gate



SurfMonkey



891-irco iron and copper gate



8950-ir Pavilion



8940-irwo Pavilion

## Follies & sculptures

Landscape lighting made to order

Architectural Detail Group, inc.



9000 9001 9002 Pull,



9010 Knob



9011knob



9030 bronze baule.str.ule



9012 iron knob



f  
IV  
22  
HC



9020spitter



9021 spitter



9022 custom water cut plaques



adg lighting  
architectural detail group  
for Review



9031 imn br.icket



9032 iron handle



9034 cover

# Landscape lighting made to order



Eden climbing roses and Japanese wisteria ascend the crisp white facade of a new poolhouse inspired by the cottages of the English countryside. Stucco color, Glacier White by Benjamin Moore



The best-laid plans are often some of the best delayed plans, imagined and sketched over decades, growing and forming along side children doing much of the same. For one Newport Beach, California, gardener and her husband, these grand ambitions lay right in their own backyard-and in the colorful mind of their designer, Peter Dunham.

INTERIOR DESIGN BY

**Peter Dunham**  
and Associates

ARCHITECTURE BY

**Bob White**

LANDSCAPE DESIGN BY

**Ru.be.nflores**

PHOTOGRAPHY BY

**Davie/Ts1y**

STYLING BY

**Sean McGowan11**

WRITTEN BY

**Stephanie, Ilmt**



# Landscape lighting made to order



adg\_lights  
Newport Beach, California



**adg\_lights** Loved seeing the outside furniture we made 1 season later.. fabrics are Peter Dunham, metal work is by ADG from an historic reboot and @hollywoodathome as featured in @verandamag .... thanks such a special client for the invitation to visit this week.

#interiordesign #plants  
#landscapearchitect

#backyard #patio #exteriordesign  
#gardens #hardscape #construction  
#landscapeovers #photography  
#flowers #landscapeconstruction  
#outdoordesign

4w



Liked by myrogi and 16 others

NOVEMBER 19

Add a comment...

Furnishings are part of the landscape

adg lighting

architectural detail group

Landscape lighting made to order

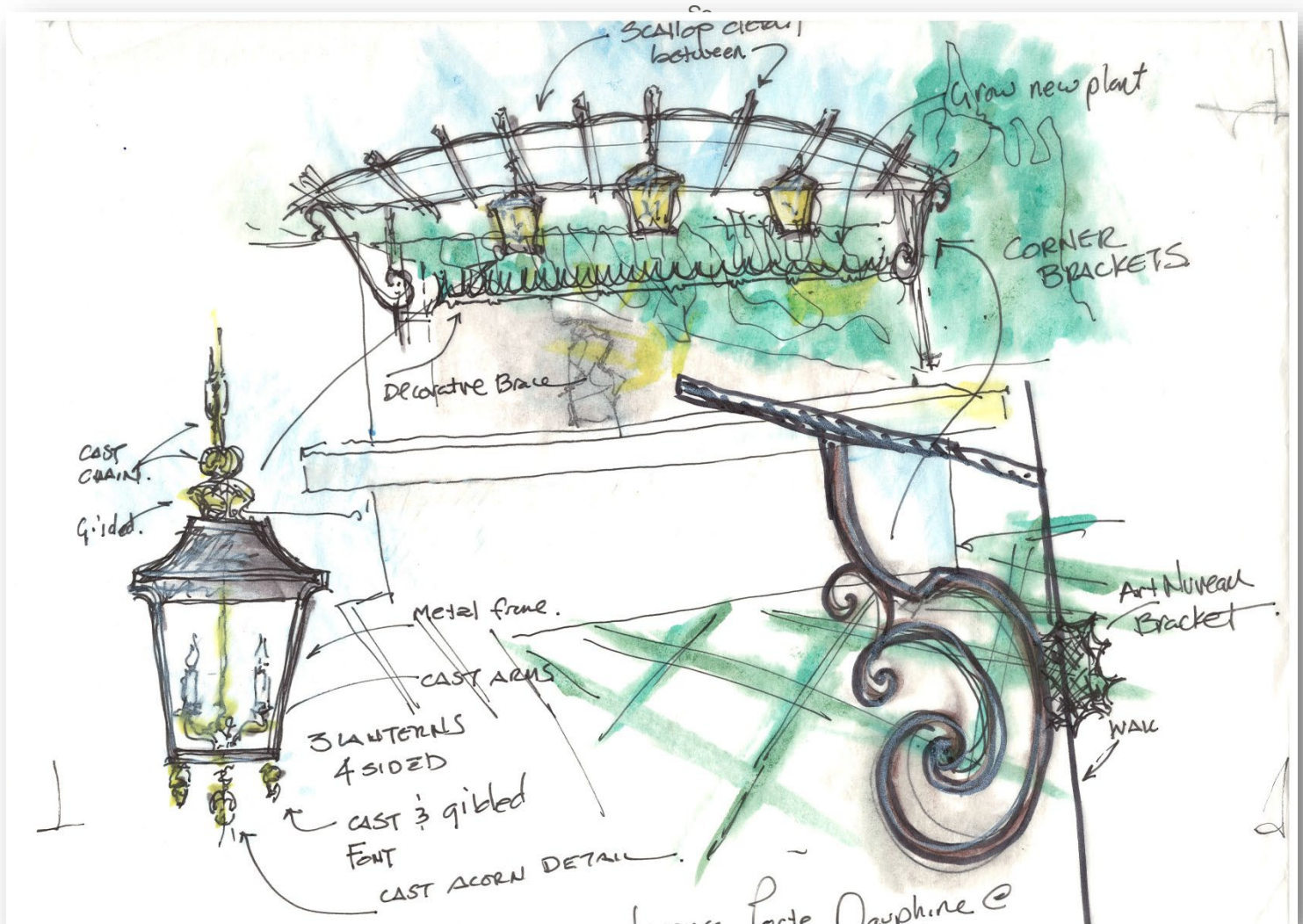

Accent hidden landscape lighting with decorative metal work & lanterns

Sketch each detail

# Landscape lighting made to order

## adg Meeting Lead Sheet

Architectural Detail Group, Inc.

Client name STYTON Date 4/14/21  
 Lead/project & task info Follow up Employee  
 Project RK/Agua Submittals To: RKL approved: 04/14/21

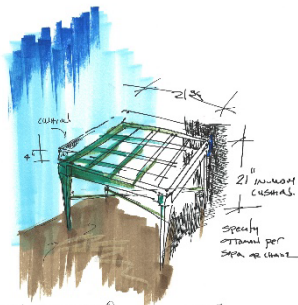

818.597.9494 L - Agoura Hills, Newport Beach  
 www.architecturaldetailgroup.com www.adg-lighting.com  
 Zig Zag General Office FORMS/ADG meeting sketch sheet.doc

## adg Meeting Lead Sheet

Architectural Detail Group, Inc.

Client name WATCO, A&H CAMP Date 4/14/21  
 Lead/project & task info Follow up Employee  
 Project RK/Agua Submittals To: RKL approved: 04/14/21

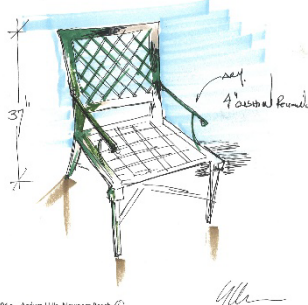

818.597.9494 L - Agoura Hills, Newport Beach  
 www.architecturaldetailgroup.com www.adg-lighting.com  
 Zig Zag General Office FORMS/ADG meeting sketch sheet.doc

## adg Meeting Lead Sheet

Architectural Detail Group, Inc.

Client name WATCO, A&H CAMP Date 4/14/21  
 Lead/project & task info Follow up Employee  
 Project RK/Agua Submittals To: RKL approved: 04/14/21

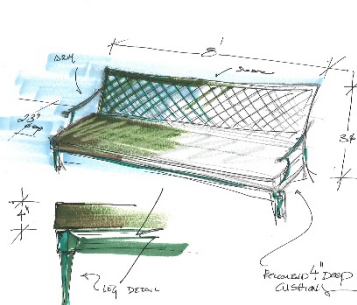

818.597.9494 L - Agoura Hills, Newport Beach  
 www.architecturaldetailgroup.com www.adg-lighting.com  
 Zig Zag General Office FORMS/ADG meeting sketch sheet.doc

## adg Meeting Sketch Sheet

Architectural Detail Group, Inc.

Client name WATCO, A&H CAMP Date 4/14/21  
 Lead/project & task info Follow up Employee  
 Project RK/Agua Submittals To: RKL approved: 04/14/21

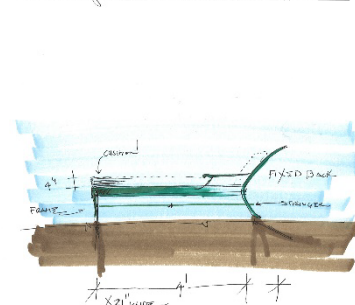

818.597.9494 L - Agoura Hills, Newport Beach  
 www.architecturaldetailgroup.com www.adg-lighting.com





# Landscape lighting made to order

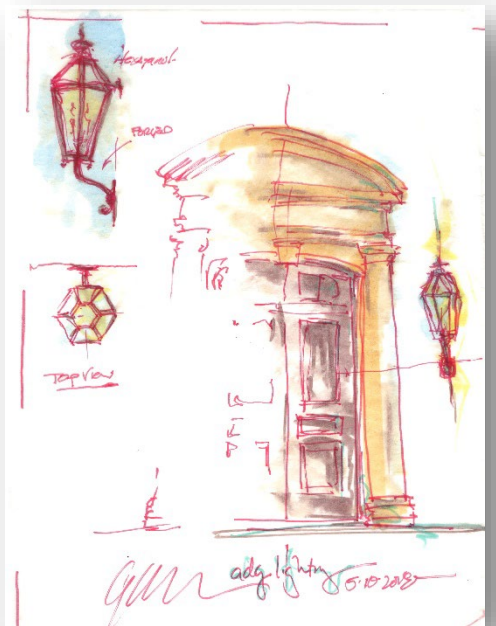
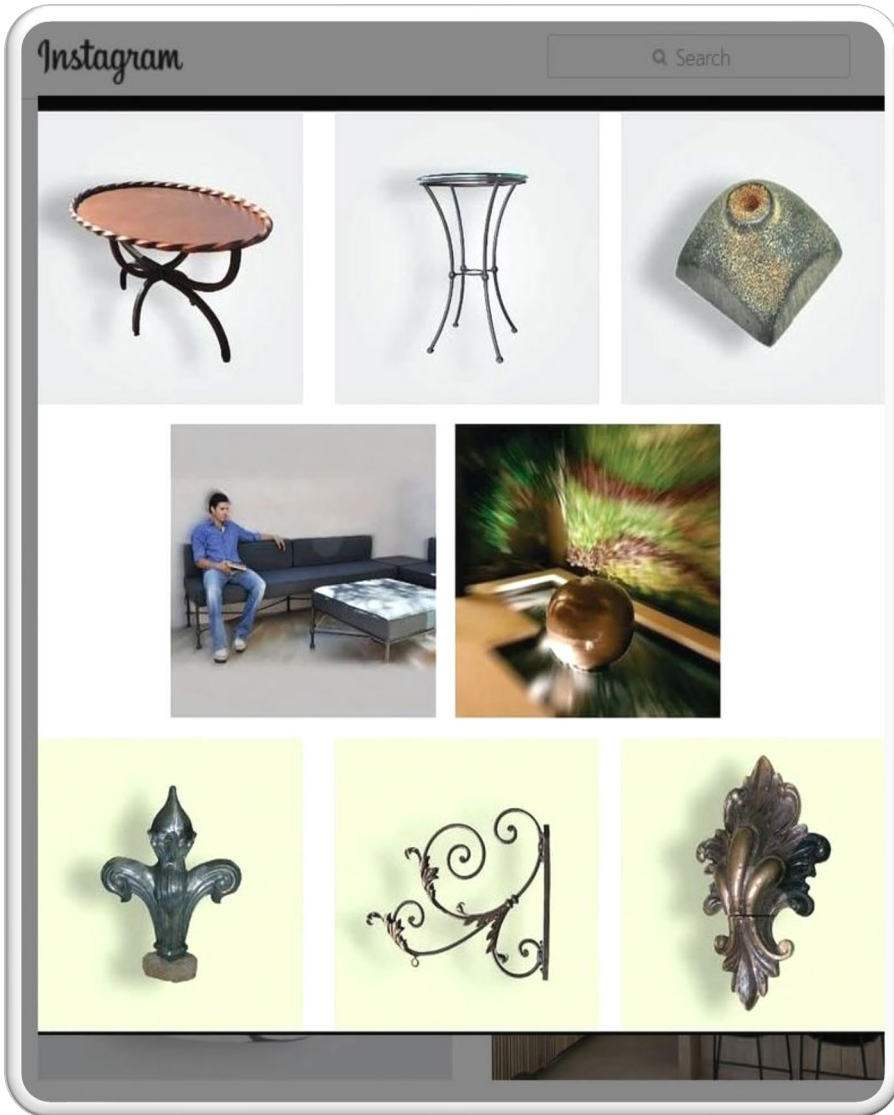

adg lighting  
architectural detail group

Landscape lighting made to order





adg lighting  
architectural detail group

landscape lighting fixtures & follies

